

Sheet P0

IGN

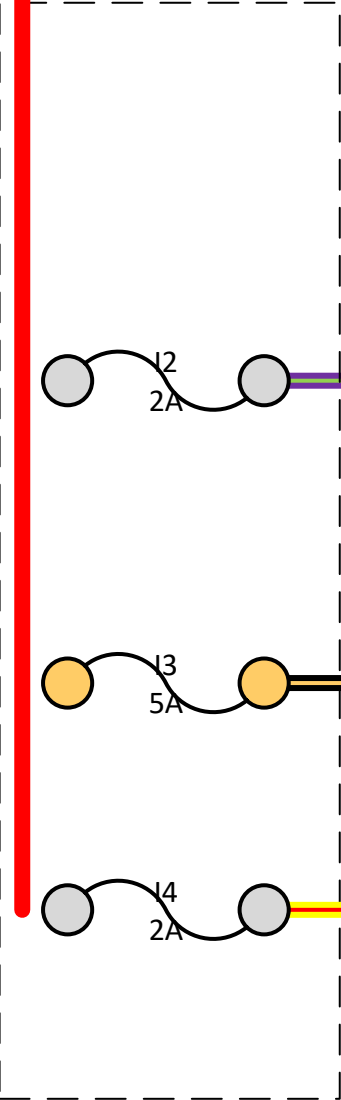

Sheet P1



—
— BB1230
—



Sheet P4

Sheet P1

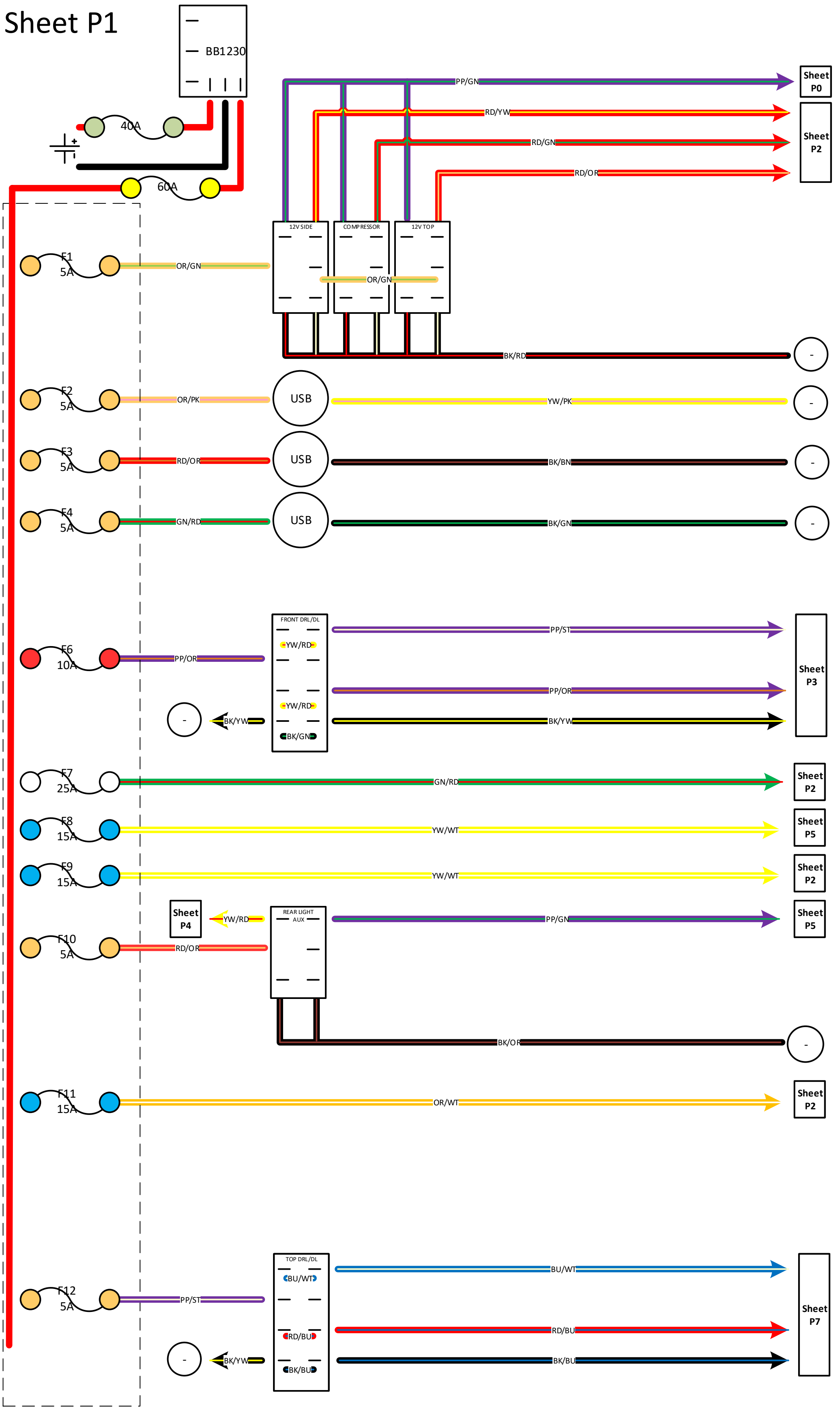

Sheet P2

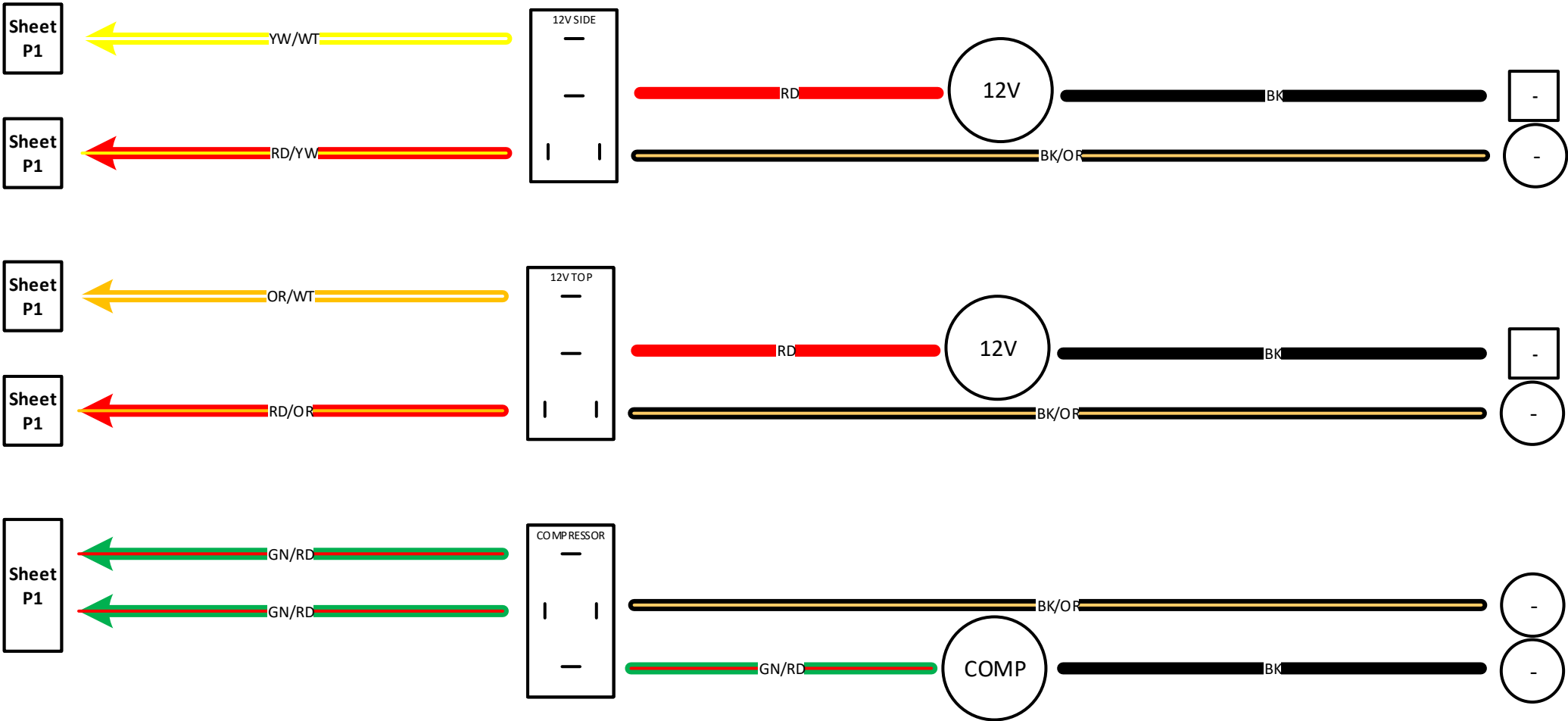

Sheet P3

Sheet P1

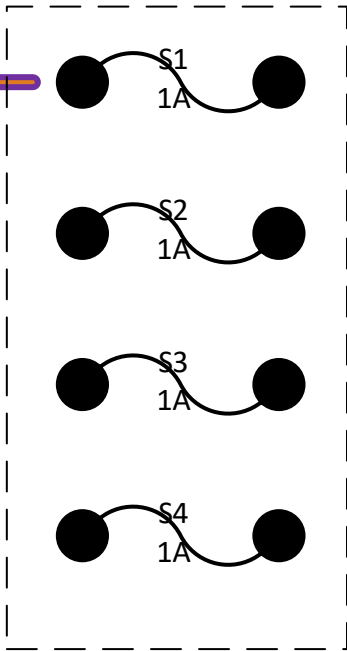
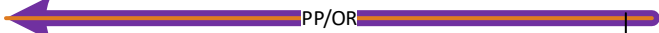

Sheet P1

Sheet P1

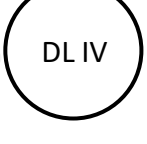
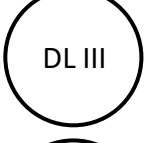
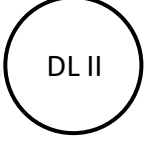
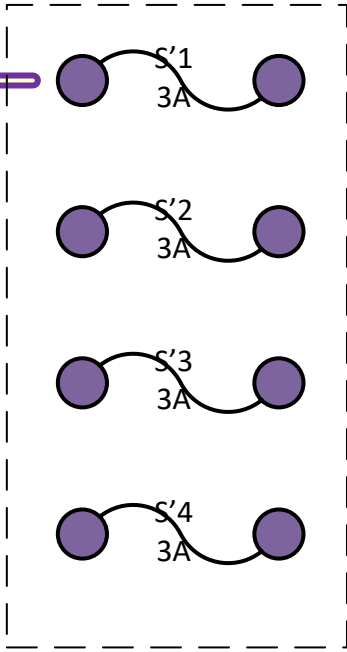

Sheet P6

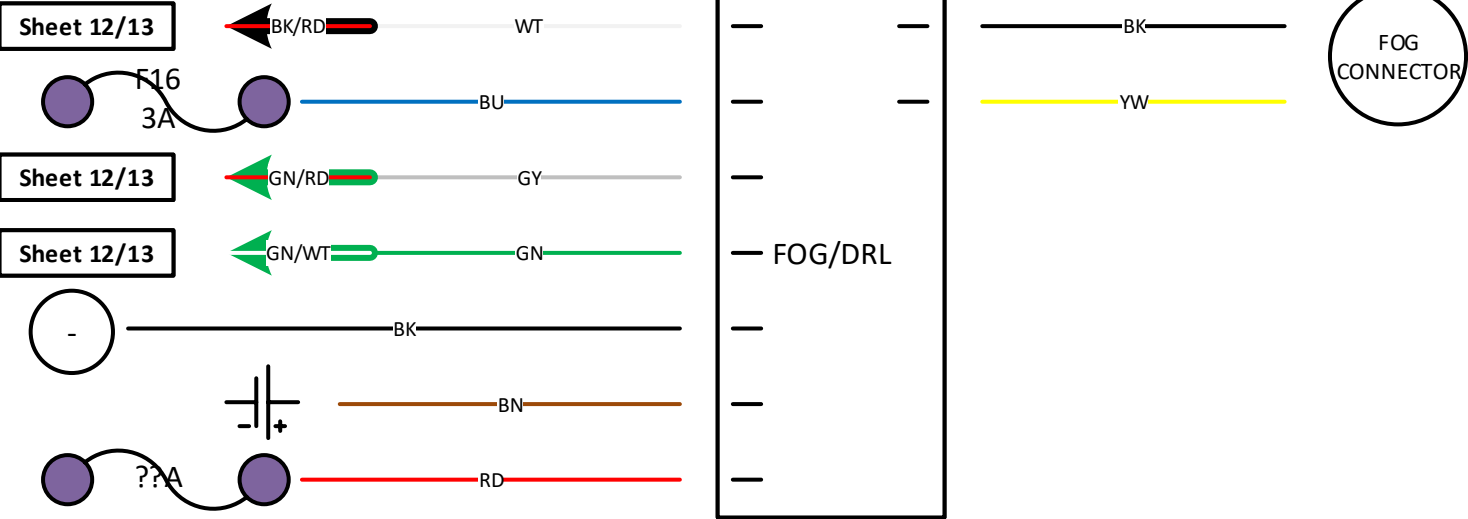

Sheet P7

